

WORLD'S NO. 1
AIRCONDITIONING COMPANY FROM JAPAN



Versatility is the mark of **Perfection**



High Static Series



Rooftop Series



Water Source Heat
Pump Series

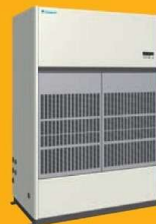

Floor Standing Series

Table of Contents

01 > Product Line-up

14 > Air-Cooled (Rooftop)

04 > Air-Cooled (Ductable)

17 > Horizontal Water Source Heat Pump

11 > Air-Cooled (Packaged)

20 > Specifications

Daikin customizes packaged line-up of airconditioning products for Indian market.

Daikin believes in being close to its customers. As a result we have developed a new range of packaged products tailor-made for Indian conditions. This new line-up of products produced in Daikin India's manufacturing facility at Neemrana, Rajasthan ensures reduced lead time and greater array of features for Indian consumers. Advanced features include cooling at high-ambient temperature, Under voltage & over voltage protection as well as phase imbalance voltage &

Phase reversal protection. We have also introduced aesthetically appealing new wired LCD remote controller, with glossy finish, for ease of usage of our packaged air-conditioner. The new line-up of packaged air conditioners gives you cutting-edge technology in air conditioners with industry-leading energy efficiency for lower power bills. These locally produced high-static pressure duct type are available up to 20 HP (16.7 TR).



Product Line-up

HIGH STATIC PRESSURE DUCT TYPE (Cooling only)

R-410A

CAPACITY	Btu/h	66,000	1,02,000	1,32,000	1,29,600	1,98,000
	TR	5.5	8.5	11	10.8	16.5
INDOOR UNIT						
		FDR65FRV16	FDR100FRV16	FDR130FRV16	FDR130FRV162	FDR200FRY16
OUTDOOR UNIT						
		RR65FRY16	RR100FRY16	RR130FRY16	RR65FRY16(Nos.2)	RR100FRY16(Nos.2)

HIGH STATIC PRESSURE DUCT TYPE (Cooling only)

R-22

CAPACITY	Btu/h	66,000	1,02,000	1,32,000	2,00,000
	TR	5.5	8.5	11	16.7
INDOOR UNIT					
		FD65DSV16	FD100DSV16	FD130DSV16	FD200DSY16
OUTDOOR UNIT					
		R65DSY16	R100DSY16	R130DSY16	R100DSY16 (Nos. 2)

HIGH STATIC PRESSURE DUCT TYPE (Cooling Only)



















R-22

CAPACITY	Btu/h	2,50,000	3,50,000	5,00,000
	TR	20.8	29.2	41.7
INDOOR UNIT				
		FD250B2Y1M	FD350B3Y1M	FD500B4Y1M
OUTDOOR UNIT				
		R130DSY16x2 Nos	R100DSY16x1 Nos / R130DSY16x2 Nos	R130DSY16x4 Nos

Product Line-up

FLOOR STANDING TYPE (Cooling only)

R-410A

CAPACITY	Btu/h	50,000	60,000	80,000	1,00,00	1,20,000	1,60,000	1,80,000	2,00,000	
	TR	4.2	5.0	6.7	8.3	10.0	13.3	15.0	16.7	
DIRECT AIR BLOW TYPE	INDOOR UNIT									
		FVGR05NV1	FVGR06NV1	FVGR08NV1	FVGR10NV1					
	OUTDOOR UNIT									
		RUR05NY1	RUR06NY1	RUR08NY1	RUR10NY1					
DUCT CONNECTION TYPE	INDOOR UNIT									
						FVPGR10NY1	FVPGR13NY1	FVPGR15NY1	FVPGR18NY1	FVPGR20NY1
	OUTDOOR UNIT									
						RUR10NY1	RUR13NY1	RUR15NY1	RUR18NY1	RUR20NY1

AIR-COOLED ROOFTOP UNITS (Cooling only)

R-410A

CAPACITY	Btu/h	62,500	93,400	1,24,500	1,54,400	1,89,000	2,48,600
	TR	5.0	8.0	10.0	13	16.0	21.0
ROOFTOP SERIES UATQ-C							
		UATQ60CGXY1	UATQ90CGXY1	UATQ120CGXY1	UATQ150CGXY1	UATQ180CGXY1	UATQ240CGXY1

AIR-COOLED ROOFTOP UNITS (Heat Pump)

R-410A

CAPACITY	Btu/h	93,300	1,21,400	1,52,600	1,90,000	2,28,000	2,47,700
	TR	7.8	10.1	12.7	15.8	19.0	20.6
ROOFTOP SERIES UATYQ-C							
		UATYQ250MCY19	UATYQ350MCY1	UATYQ450MCY1	UATYQ550MCY1	UATYQ600MCY1	UATYQ700MCY1

HORIZONTAL WATER SOURCE HEAT PUMP

R-410A

CAPACITY	Btu/h (Cooling)	9380	17907	22682	29913	34791	42636
	Btu/h (Heating)	11153	20806	24217	30868	34961	44341
	TR (Cooling)	0.78	1.49	1.89	2.49	2.90	3.55
	TR (Heating)	0.93	1.73	2.02	2.57	2.91	3.70
UNIT							
	MWH010DRP	MWH020DRP	MWH025DRP	MWH030DRP	MWH040DRP	MWH050DRP	

CAPACITY	Btu/h (Cooling)	54574	64806	83736	100620	113922	127907
	Btu/h (Heating)	56757	67398	87086	104645	118479	133023
	TR (Cooling)	4.55	5.40	6.98	8.39	9.49	10.66
	TR (Heating)	4.73	5.62	7.26	8.72	9.87	11.09
UNIT							
	MWH060DRP	MWH070DRP	MWH080DRP	MWH100DRP	MWH125DRP	MWH150DRP	

Daikin's Packaged Air-conditioners are engineered to meet high static and large airflow for wider coverage requirements.

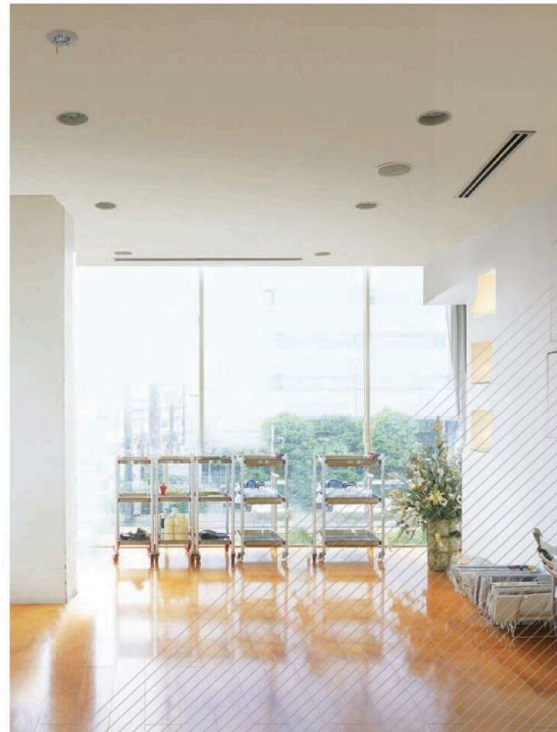

Air-Cooled (Ductable)

AIR CONDITIONERS

High static pressure duct type**

R-410A FDR-FRV/FRY Series
R-22 FD-DSV/DSY Series

▶ FDR65FRV16



▶ FDR100FRV16



▶ FDR130FRV162*



▶ FDR200FRY16



Improved Features

New wired LCD remote controller

New LCD based wired type remote handset with alphabetic error display like HP, LP, SPPR, indoor fan current sensor etc. In-built energy saver dedicated button and glossy finish.

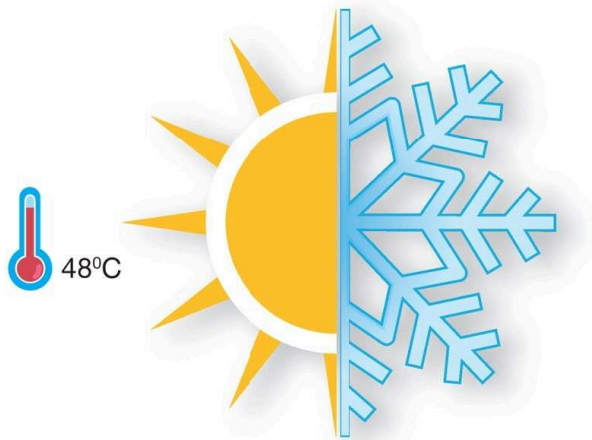
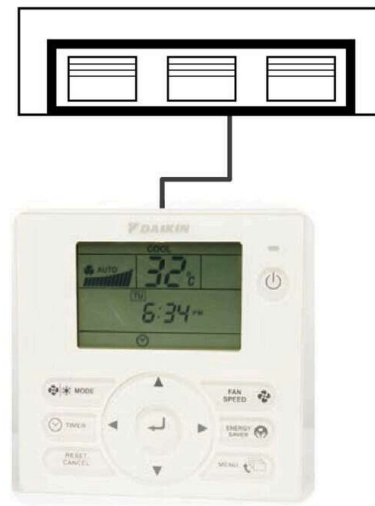

High performance even at high ambient temperature

Always keeping your comfort in mind, Daikin ducted air conditioners work at high ambient temperature (48°C) without tripping. Get the best out of Daikin ducted air conditioners even in hot weather conditions.

Note: *Available in twin circuit also. **Models available in R-22 also (5.5 ~ 16.7 TR).

Best in class Air Conditioning Components

Best in Class high grade Components of Daikin Ducted Air Conditioners ensures high energy efficiency, High Cooling, high comfort and high reliability.



Under voltage and over voltage protection

Given the erratic electricity supply it becomes important that your air conditioners are guarded against under voltage and over voltage. Daikin ducted air conditioners offer protection against voltage fluctuation thus enhancing the operating life of your air conditioners.

Phase imbalance voltage

It is vital that your air conditioner is protected against imbalance and Daikin duct air conditioners offer this protection to ensure reliable operation of the air conditioner. Electrical equipment especially motors and their controllers will not operate reliably on unbalanced voltages. Greater imbalances may cause overheating of components and damage the air conditioners.

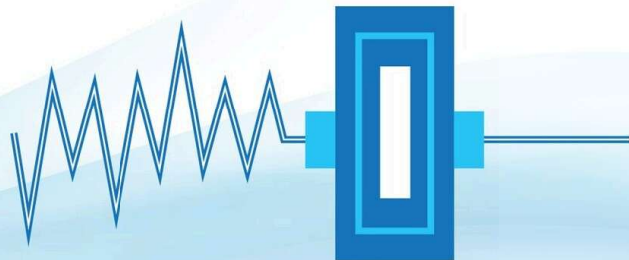

Phase Loss Protection

In case of any phase loss Daikin machine will display error on its controller.



Phase reverse protection

Phase reversal could cause serious problems therefore much care is required to protect the motor from such type of fault. Daikin duct air conditioners offer protection from phase reversal thus enhancing the life of the air conditioners.

Pre-charged refrigerant

Daikin India's FDR65, FDR100, FDR130 and FDR200 models are available with pre-charged refrigerant for 7.5 meter piping length. No need for additional refrigerant charge on-site if piping length is upto 7.5 meters.



Comfortable

Superior air distribution for comfortable living

The conditioned air can be effectively distributed to every corner of the room through the ducting and this ensures a pleasant environment for comfortable living.

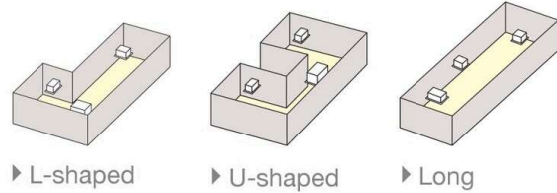

Air discharge orientation

FDR65-200 models come with standard horizontal air discharge.

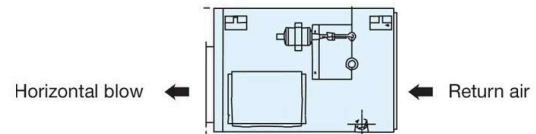

Flexibility of air supply

Air flow can be adjusted by using Fan speed button on LCD Remote controller.

Versatility

Multiple rooms can be cooled together at the same time by using just one unit of fan coil unit.

Fresh air intake for healthy living

Fresh air can be introduced into the building through the design of fresh air intakes. This will help to improve the indoor air quality.

Compact

Compact design of built-in type helps blend with interior decor

Indoor models are compact in size and designed with twin coil structure. This design effectively saves space during installation.



Compact size

To fit in tight ceiling spaces, few models are available with 450 mm height only

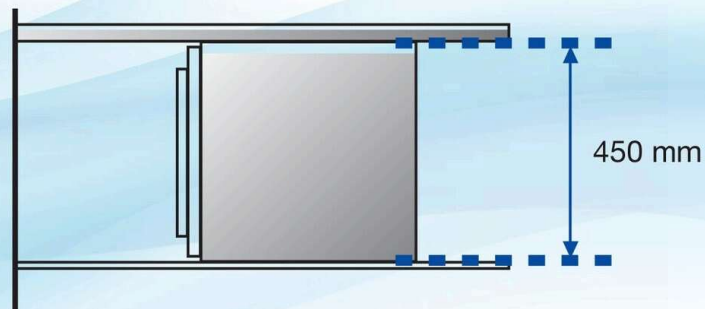

Work & Servicing

Easy maintenance

The simple design concept has provided the ease of maintenance and servicing. Access to the internal part of the unit can be from the service panel or other side of the unit by loosening a few screws.

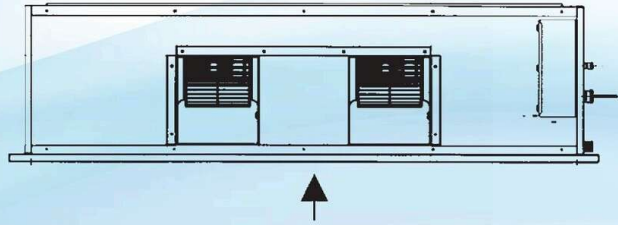

Remote Controller

Wireless & Wired Remote Controllers



NEW

*4P408280-1A

*Applicable models upto FDR200

Others

Air Filter as standard

Washable Air Filter is equipped as standard.

Outdoor Unit

Scroll compressor

All outdoor units are using scroll compressor which has better energy efficiency and quiet in operation.

Anti-corrosion of heat exchanger fin

The heat exchanger fin of outdoor units are anti-corrosion treated.

Scroll compressor

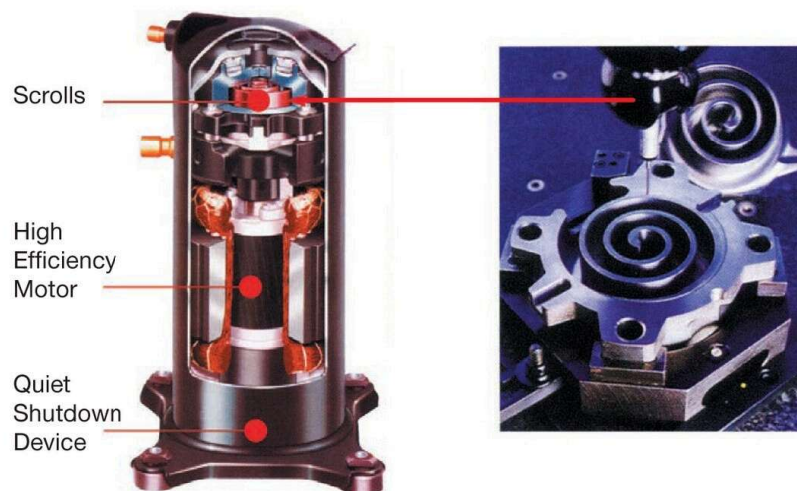

Advantage of High Performance Components FDR-FRV Series (5.5TR~16.5TR)

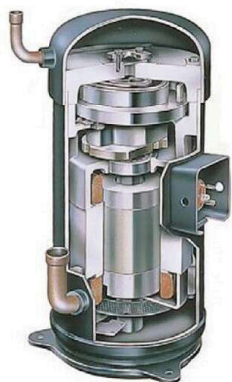

Compressor

Compressor is known as heart of any Refrigeration & Air conditioning system.

Daikin uses highly efficient Scroll compressor which ensures better Volumetric Efficiency, Low noise ,reliable operation, built in safety.

ODU Fan

Aerodynamic design High efficiency Propeller Fan for optimize Airflow distribution thus better heat transfer& lower noise level best suited for high Ambient conditions.

The Outdoor fan and fins that act as heat syncs draw the heat away so the unit doesn't overheat.

The outdoor condensing unit becomes very hot with all that overheated refrigerant running through it. The Outdoor fan and fins that act as heat syncs draw the heat away so the unit doesn't overheat.



Motor

High RPM motors to improve airflow ,better insulation

Thermal Overload protector used for motor safety.

HP/LP Switch

These switches are design for Highly Precise Setting & Repeatability

HP Switch: The high pressure switch cuts-off power supply in case of excess compressor discharge pressure thereby preventing equipment damage.

LP Switch: The low pressure switch monitors the refrigeration system for loss of refrigerant charge.

It also helps in stopping the evaporator (indoor) coil from freezing due to a clogged/dirty filter or lower airflow over the coil.



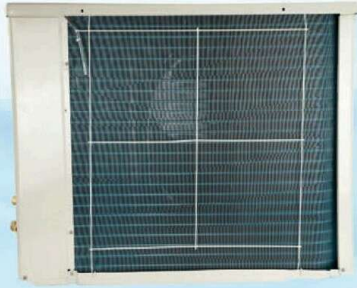

Heat Exchanger

Blue Fin Condenser and Hydrophilic special coating on the fin of the heat exchanger prevents corrosion, extending the life of the unit to increased enhance performance.

Optimum Area Heat exchanger of both 7mm tubes & 3/8" Heat Exchanger increasing heat transfer area which increases cooling capacity & Performance during high ambient temperature.

TEV

Thermostatic expansion valve (TEV) regulates refrigerant flow to cater to variations in heat load and make the system more efficient by controlling Superheat & matches system capacity.

over a broader temperature range. It increases the flow of refrigerant to provide better cooling at higher temperatures. It's design Protects the compressor motor by preventing liquid slugging, which can damage compressors.



Drier

Filter Drier for liquid line protects refrigeration and air-conditioning system by removing High moisture, acids and solid particles. With these contaminants eliminated, systems are safer from harmful chemical reactions. These are shock resistant built in steel shell construction.

Stop Service Valve

Function: Stop valve is used to connect indoor and outdoor units.
Good Quality of stop Valve ensures high Reliability.



Metallic PCB Box

Metallic PCB Box ensures safety from Fire

Air-Cooled (Packaged)

AIR CONDITIONERS - Flexible design and great reliability.

Floor standing type

R-410A



FVGR10NV1



RUR10NY1



FVPR10NY1



RUR10NY1

▶ Direct air blow type

▶ Duct connection type



▶ Nice, cool air in the factory or in the cafeteria

Enhanced Varieties of Factory Modification and Optional Accessories

- Standard model
- Factory modification
- Contact sales for more information

	Floor Standing Type	
	Direct Air Blow	Duct Connection Type
FACTORY MODIFICATION		
Auto restart	●	●
Modify wiring for central control adapter kit (DAT107A55) installation	●	●
Change fan motor and pulley	-	●
Discharge grill plenum chamber	●	●
Side discharge grill on discharge plenum chamber	●	●
Lower drain pan	-	●
Front suction high efficiency filter chamber	-	●
Front suction base flange for front suction high efficiency filter chamber	-	●
Suction grill for front suction high efficiency filter chamber	-	●
Fresh air inlet	-	●
Rear suction	●	●
Drain pump	●	●
Remote sensor (Thermistor for suction air)	●	●
All fresh air application	●	●
Low outdoor temp. 15°C application and long pipe 70m application	●	●
OPTION		
Central control adaptor kit(external terminal for ON/OFF, abnormal) ¹	DTA107A55	
LCD remote controller ²	BRC1C62	
Intelligent touch controller ²	DCS601C51	
Central remote controller ²	DCS302CA61	
Unified ON/OFF controller ³	DCS301B61	
Schedule timer ³	DST301BA61	
Remote sensor (Thermistor for suction air) ³	KRCS01-1	
Remote controller	BRC1NU64	

Notes: 1. Wiring modification is needed on floor stand model to connect with central control ADP kit.

2. Need to use central control adapter kit for option connection.

3. Central control adapter kit and LCD remote controller is necessary for option connection.

Quiet Operation

Equipped with scroll compressor for quiet operation
Smooth running, low vibration, low operating sound.

Outdoor unit	Sound level	
	0.92	1.76
RUR05NY1	59 dB	60 dB
RUR06NY1	59 dB	60 dB



Direct Air Blow from Indoor Unit with Plenum

Comfortable factory airconditioning, using multiple indoor units installed in accordance with the space.

Installation is next to walls, so units will not affect the factory layout even if some changes are made.

Direct air blow type

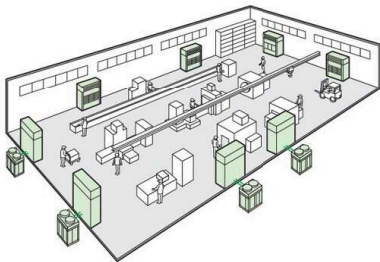

Air Blow via Connected Ducts

Comfortable airconditioning of the entire factory by connecting a blow duct at the top of the indoor unit.

Duct connection type

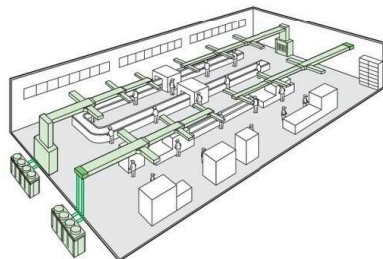

Note: Ducts to be procured locally.

Easy Operation

Digital remote control comes standard with indoor unit

Temperature setting is possible by button operation. The set temperature is conveniently displayed on the LED.

Floor standing type (Standard accessory)



- 1 On/Off button
- 2 Fan button
- 3 Temp. setting up
- 4 Temp. setting down
- 5 Mode button
- 6 LED display
- 7 Compressor operation lamp
- 8 Fan operation lamp
- 9 Cool operation lamp

Note 1: It cannot be used for FVPGR10-20NY1

Duct type (Optional accessory)



- 1 Power
- 2 Temperature scale
- 3 Temperature setting
- 4 Mode setting
- 5 Next setting
- 6 Fan indicator lamp
- 7 Cool indicator lamp
- 8 Compressor 2 indicator lamp
- 9 Compressor 1 indicator lamp
- 10 Temperature sensor

Design Flexibility

Designed for long refrigerant piping

50m maximum length and 30m maximum level difference to cover medium and large-scale building needs.

Outdoor unit roof installation possible for plenty of leeway

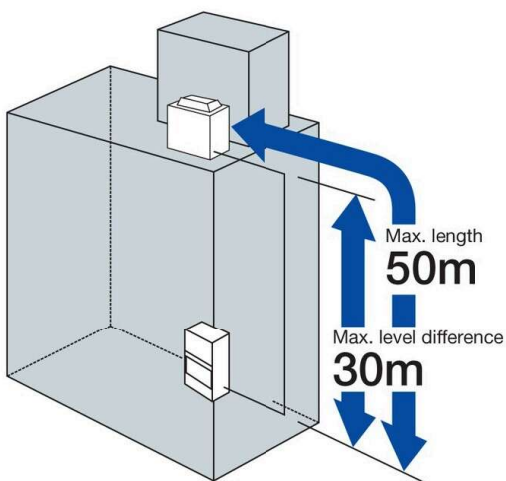

Refrigerant pre-charged for upto 7.5 metres

Allowable refrigerant pipe length and level difference

	Pre-charged ¹	Max. length	Max. level difference
RUR05NY1-20NY1	7.5 m	50 m (Equivalent length 70 m)	30 m

Note 1: Additional refrigerant charging is required if the refrigerant pipe is longer than the indicated length.

4-direction piping affords more freedom of layout (Applies to RUR05N/06N)

Piping can be run from the front, bottom, right or rear surface according to how the unit is installed.

In case of RUR08-20N, piping can be drawn out in two directions - front and under side.

Durability

Heat exchange fins provided with anti-corrosion treatment (Applies to all outdoor units)

To achieve increased durability by improved resistance to salt corrosion and atmospheric pollution, coated PE fins (with special acrylic pretreatment) are used for the heat exchanger of the outdoor unit.

Space Savings

Installation space is saved, thanks to a more compact outdoor unit. This also makes it easier to install.



▶ Previous 20HP outdoor unit
RUG10AU1 X 2



▶ New RUR20NY1 (20HP)

53%

Space saved compared to previous model

Air-Cooled (Rooftop)

AIR CONDITIONERS - The Comfort with Higher Efficiency.

Rooftop

R-410A



▶ UATQ60/90/120/150/300/180/240CGXY1 (Cooling Only)

▶ UATYQ250/350/450/550/600/700MCY1 (Heat Pump)

▶ With optional economiser kit*

Package Unit

Daikin's new range of rooftop packaged units has been developed specifically to suit commercial applications and are designed to be easy to install, requiring only ducting (and associated fittings), power/control wiring and drain piping. Along with the light grey colour, the flat top and compact design gives an aesthetic and neat appearance when installed in line of sight. The unit cabinet is made of powder coated sheet metal especially suitable for outdoor use. All parts of the structure are fastened with corrosion resistant screws and bolts.

High Operating Range

Designed for high ambient application. Continuous operation at an outdoor ambient temperature up to 52°C.

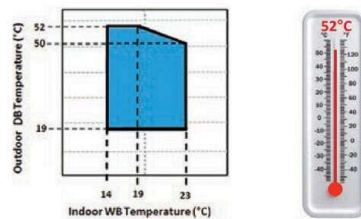

Flexible Air Supply utilising Variable Pitch Pulley

Utilising the Variable Pitch Pulley (VPP) driven supply fan, VPP can be adjusted on site to meet a wide range of required air flow and ESP without the need to change the pulley and belt.



Convertible Return and Supply Air*

Unit can be easily converted from horizontal to vertical (downward) supply and return air duct configuration by relocating the panels and supply air fan mounting.

Scroll Compressor

Units are equipped with high efficiency and reliable scroll compressors. Each compressor is mounted on rubber vibration isolators in order to reduce the noise level and vibration transmissions.

Powder Coated Condensate Drain Pan

The sheet metal condensate drain pan is powder coated to resist corrosion.

Slots for 2 Inch Return Air Filters

A 2 inch rail is provided as standard in instances where a field supplied filter casement needs to be installed.

Higher Energy Efficiency Rating

The UATQ-C series is designed to achieve high energy savings. Its performance is claimed to be among the best in the market.

*Selected models (Refer data book)

Standard Handset

User friendly wired remote controller for UATQ-C series with following functions:

- 7 days programmable timer (on/off)
- Compressor running display
- Real time clock
- Key lock function
- Energy saving mode
- Error code display



Rooftop Panel for UATYQ - MCY1 series comprises all starting, operating and safety controls setting.

- 7 days programmable timer with 3 set of ON/OFF, timer/day
- Dirty filter indication
- Alarm & Warning diagnostic
- Password protection for advanced setting



Component Features

1 Condenser Fan and Motor

Fans are of propeller type, direct driven by weatherproof electrical induction motors. Condenser fan motor has class F insulation and splash-proof enclosure of up to IP55*.

- UATQ60/90/120/150/180/210/240/300CGXY1: IP55
- UATYQ600/700MCY1: IP55
- UATYQ250/350/450/550MCY1: IP44

2 Condenser

Condenser coils are manufactured from seamless inner grooved copper tubes mechanically bonded to Aluminium fins to ensure optimum heat transfer. All coils are tested against by Nitrogen holding at 609psig and highly precise Helium leak test at 235psig. All standard coils are up to 3 rows/14-16 FPI, 3/8" (9.52mm) O.D. tubes.

UltraGold Fin is offered as standard (1000hrs Salt Spray Tested), which has longer life span under corrosive environment.

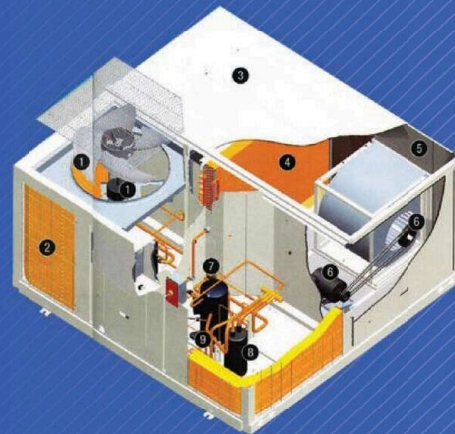

3 Casing / Structure

The unit casing used in UATQ-C & UATYQ-MCY1 series is made of zinc coated galvanized steel sheets. It is further coated with an electrostatic powder coat and then oven-baked for a tough and lasting weather resistant finish. Zinc plated screws are used throughout to further reduce possibility of unit rusting.

4 Evaporator

Evaporator coils are manufactured from seamless inner grooved copper tubes mechanically bonded to aluminium fins to ensure optimum heat transfer. All coils are tested against by Nitrogen holding at 609psig and highly precise Helium leak test at 235psig. All standard coils are 3-4 rows/14-16 FPI, 3/8" (9.52mm) O.D. tubes.

UltraGold Fin is offered as standard (1000hrs Salt Spray Tested), which has longer life span under corrosive environment.

5 Insulation

All possible areas of condensation are insulated by PE, Polythelene. Panel insulation is 10mm thick while drain pan insulation is 5mm thick.

6 Evaporator Fan and Drive

Blower is DWDI centrifugal, forward curved type. It is mechanically and dynamically balanced and mounted on a rigid shaft in a self aligned bearing

block. The motor is fitted with an adjustable V-belt drive as standard. It has class B insulation and dripping water proof, IP22.

7 Expansion Device

Electronic Expansion Valve is used to ensure accurate control of refrigerant flow.

8 Compressor

Compressor used in UATQ-C & UATYQ-MCY1 Series Packaged Units are hermetically sealed scroll type. All the compressors are provided with an internal overload protection.

9 Refrigerant Circuit

Each refrigerant circuit have independent electronic expansion devices, HP/LP switch and refrigerant line service pressure ports as standard factory HP/LP switch and refrigerant line service pressure ports as standard factory installed.

Economiser*

Economiser is available as an option to cater for horizontal or vertical air discharge/return.

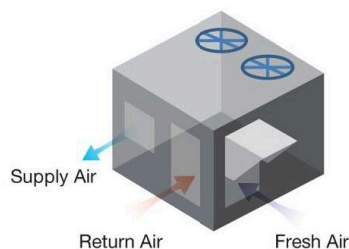

▶ Horizontal Discharge / Return

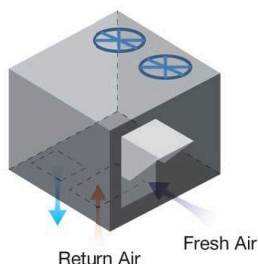

▶ Vertical Discharge / Return

Optional Features

3rd Party Thermostat*

For application that requires uniform thermostat outlook with other electrical appliances. 3rd Party thermostat can be connected to the factory supplied module via the contact point available on the PCB board.

Basic BMS Connection

Unit's standard PCB board provides dry contact for basic BMS connection. Input signal will go to dry contact ON/OFF, COOL/HEAT and 4 to 20 mA temperature adjuster while output signal will come from ON/OFF, COOL/HEAT, ALARM and DEFROST dry contact.

CO₂ Sensor*

Field specified CO₂ sensor can be easily plugged on the control board's dry contact, which is available on the economiser extension board.

Auxiliary Heater*

Auxiliary heater connection point is available on the standard PCB for field supplied heater connection.

*Combination possible only with R-410A Heat Pump rooftop unit

Horizontal Water Source Heat Pump



► MWH-D

Energy saving and environmental protection

Pioneer of Environmental Protection

Water source heat pump MWH-D series use environmental refrigerant R410A. R410A is higher volumetric capacity, w/o element of Cl, improving the efficiency, not destroying the ozone layer.

Refrigerant	ODP	Temperature slip	Volumetric capacity	Efficiency
R410A	0	0.5	141	100
R407C	0	4.4	95	98
R22	0.05	0	100	100

Notes:
 ■ ODP is a relative value of R11
 ■ Volumetric capacity and efficiency are relative value of R22

High Efficiency and Energy Saving

At present, McQuay measures ACOP instead of COP to identify water source heat pump efficiency. ACOP is Integrated cooling and heating Coefficient of Performance for the whole year. The highest ACOP is 4.94, for MWH060DRP, which is higher beyond national standard (GB) 4.55.

$$ACOP = 0.56 * EER + 0.44 * COP$$

EER = cooling capacity/cooling input power,

COP = heating capacity/heating input power.



► This test room is Nationally Recognized Testing Laboratory

Reproducible Energy Sources

The MWH D series take use of ground water, surface water, ground and other resource which include low-quality energy which is renewable energy sources.

The unit can be applied to water loop system, water source system, ground water system or other water system due to wide-range working condition.



Flexible application

Flexibility in Static Pressure Selection

McQuay MWH-D series (1HP-7HP) take use of high-performance fan motor. For 8HP-15HP units, 4 types of ESP option is provided to meet air supply requirement.

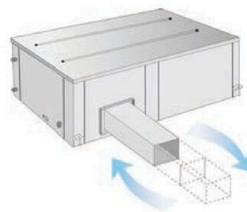

► 1HP-7HP

Easy Maintenance

MWH-D series are designed with assess doors and knobs in three directions, which is easier for service engineers to change parts on site.

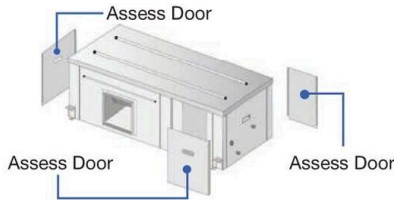

Convenient Installation

MWH-D series have charged refrigerant R410A before shipment. Customers only need to wiring, install water pipes and air ducts on job site. So installation cost is highly reduced.

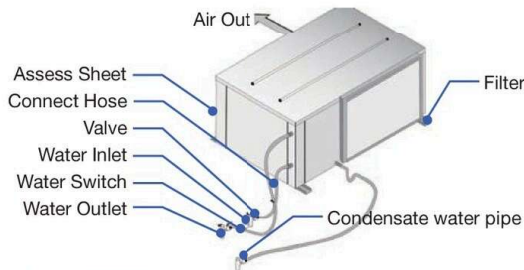

With full accessories

Standard MWH-D series come along with accessories including: wired controller, 8m communication cable, moldproof air filter and waterpipe joint and rubber isolator make installation more convenient and easier.

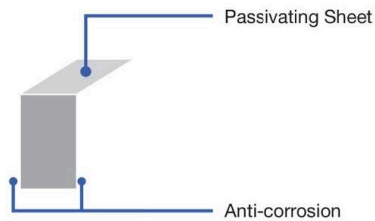

Safety & Reliability

Multiple Protections

MWH-D series are designed with multiple protections: the high and low pressure protection, water leakage protection and circulating water temperature protection. The wired controller is installed with sound, light and code alarm, which feedback fault information fastly to make sure formal operation.



No Refrigerant Liquid Attack

MWH-D series are designed with liquid accumulator which can store redundant refrigerant when operation condition changes so that to prevent compressor from liquid attack.



Scroll



Liquid Accumulator

Superior IAQ

MWH-D series standard filters are washable to ensure the coil clean and run efficiently, to provide clean indoor air continuously.

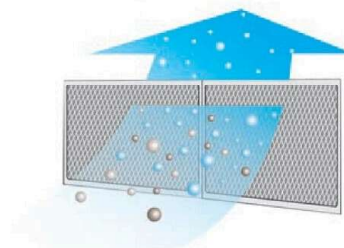

Intelligent Control System

Intelligent Control System

MWH-D series adapt various ways of control, including standard wired controller(MC322) and other options, for example: wireless remote card controller, central controller (max to 64 units), Smart Commander and supporting BMS system under Modbus.



▶ Wired Controller (MC322+8m wiring) (Standard)



▶ Wireless Card Type (Optional)



▶ Centralized Controller (Optional)



▶ Modbus (Optional)



▶ Smart Commander Software (Optional)

Note: For above option, please contact factory in advance

Performance Curve

Different Conditions

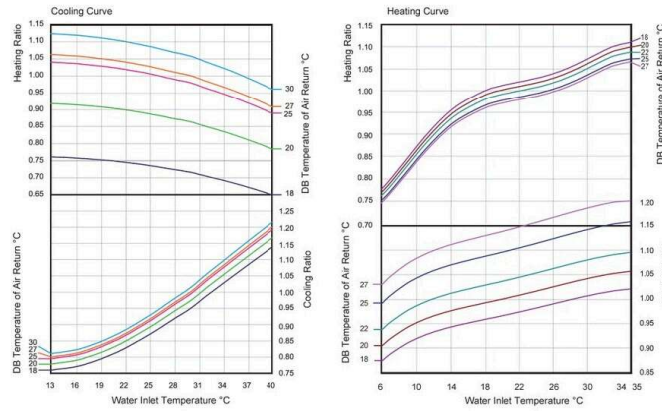

Different Air Flow

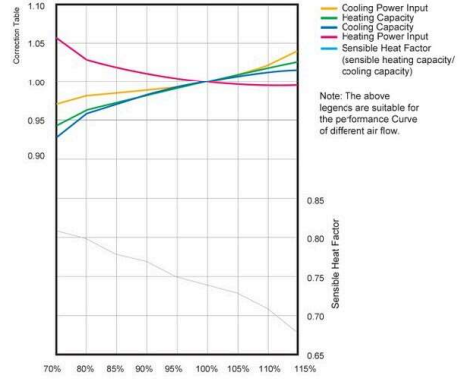

Note: The performance curve of different conditions is tested on normal water flow.

Correction Table of Water Temperature Difference

Water Inlet/Outlet Temperature Difference	10	9	8	7	6	5	4
Water Flow	0.500	0.560	0.620	0.720	0.840	1.000	1.130
Cooling Capacity	0.986	0.990	0.994	0.997	0.999	1.000	1.001
Heating Capacity	0.978	0.984	0.990	0.997	1.001	1.000	0.994
Cooling Power Input	1.043	1.034	1.025	1.016	1.008	1.000	0.989
Heating Power Input	0.989	0.992	0.994	0.996	0.998	1.000	1.004

Note: specification is based on 30°C water inlet temperature, 27°C (DB) air return temperature.

Operating Range

Operating Range	Cooling	Heating
Indoor Air DB Temperature	16—35°C	10—30°C
Cooling Capacity	13—40°C	6—35°C

Note: If the units run beyond above operating limit, it may cause damage to the units.

Specifications

HIGH STATIC DUCT TYPE (Cooling only)

R-410A

			5.5TR	8.5TR	11.0 TR	10.8 TR	16.5 TR		
Model	Indoor Unit		FDR65FRV 16	FDR100FRV 16	FDR130FRV 16	FDR130FRV 162	FDR200FRY 16		
	Outdoor Unit		RR65FRY 16	FDR100FRY 16	RR130FRY 16	RR65FRY 16(2Nos)	RR100FRY 16(2Nos)		
Nominal Cooling Capacity		Btu/ Hr	66000	102000	132000	129600	198000		
		KW	19.3	29.9	38.7	38	58		
Actual Capacity		%	Minimum 90% of Nominal Capacity						
Nominal Total Input Power (Cooling)		W	6400	11000	14600	13000	21600		
Running Current		A	11	19	23	22	38		
Power Source		V/Ph/ Hz	415/3/50						
Refrigerant Type		---	R-410A						
INDOOR UNIT	Control	Operation	---						
	Air Flow	High	cfm	2200	3400	4400	4400	6600	
		Medium	cfm	2045	3100	3850	3850	5800	
		Low	cfm	1890	2800	3330	3330	5000	
	Static Pressure	High	Pa	50	50	60	60	80	
	Sound Pressure Level (H)		dBA	51	52	54	54	59	
	Unit Dimension		Height x Width x Depth	mm	450x1170 x700	450x1660 x700	470x1700 x940	470x1700 x940	590x1885 x1145
	Packing Dimension		Height x Width x Depth	mm	465x1370 x720	585x1880 x740	620x1930 x990	620x1930 x990	755x2130 x1250
	Unit Weight		kg	60	95	125	130	175	
	Condensate Drain Size		mm	40.5					
OUTDOOR	Unit Dimension		Height x Width x Depth	mm	930x1025 x410	930x1200 x550	930x1650 x620	930x1025 x410	930x1200 x550
	Packing Dimension		Height x Width x Depth	mm	1080x1170 x470	1080x1350 x620	1088x1846 x720	1080x1170 x470	1080x1350 x620
	Unit Weight		kg	96	147	173	96	147	
	Pipe Connection	Type	---	Liquid (Flared) & Gas (Brazed)					
		Size	Liquid	mm	12.7	12.7	15.9	12.7	12.7
			Gas	mm	22.2	28.6	28.6	22.2	28.6
Refrigerant Pre-Charged (At 7.5m Pipe Length)		kg	4.4	5.7	8	2X4.4	2X5.9*		

Note: ■ All specifications are subject to change by the manufacturer without prior notice.

■ Cooling capacity is based on the conditions below:

Cooling - 27°C DB / 19°C WB indoor and 35°C DB outdoor.

■ Refrigerant (R-410) is pre-charged at factory shipment (Outdoor Unit).

Specifications

HIGH STATIC DUCT TYPE (Cooling only)

R-22

Model	Indoor unit		5.5 TR	8.5 TR	11.0 TR	16.7 TR	20.8 TR	29.2 TR	41.7 TR	
	Outdoor unit		FD65DSV16	FD100DSV16	FD130DSV16	FD200DSY16	FD250B2Y1M	FD350B3Y1M	FD500B4Y1M	
			R65DSY16	R100DSY16	R130DSY16	R100DSY16x2	R130DSY16x2 Nos	R100DSY16x1 Nos R130DSY16x2 Nos	R130DSY16x4 Nos	
Capacity	Btu/h		66000	102000	132000	200000	250000	350000	500000	
	kW		19.34	29.9	38.7	58.6	73.27	102.58	146.53	
Total Input Power	W		6450	9500	13000	19510	25568	36783	51720	
Running Current	A		11	17	22	33	44.4	62.9	89.7	
Power Source	V/Ph/Hz		415 / 3 / 50							
Refrigerant Type			R-22							
INDOOR UNIT	Control	Operation	LCD Wired Controller							
	Air Flow	High	cfm	2200	3400	4400	6600	8000	10500	15000
		Medium	cfm	2045	3100	3850	5800	-	-	-
		Low	cfm	1890	2800	3330	5000	-	-	-
		High	Pa	50	50	60	80	200	343	250
	Sound Pressure Level		dBA	53	53	57	59	63	66	68
	Unit Dimension	Height	mm	450	450	470	590	855	1486	1486
		Width	mm	1170	1560	1700	1885	1794	2022	2174
		Depth	mm	700	700	940	1145	850	1069	1336
	Packing Dimension	Height	mm	465	585	620	755	1154	1766	1766
		Width	mm	1370	1780	1930	2130	2052	2279	2431
		Depth	mm	720	740	990	1250	1188	1422	1684
	Unit Weight	kg		60	90	128	175	343	440	606
	Condensate Drain Size	mm		40.5				25.4	25.4	25.4
INDOOR UNIT	Unit Dimension	Height	930							
		Width	mm	1025	1200	1650	1200	1650	*1200/1650	1650
		Depth	mm	410	550	620	550	620	*550/620	620
	Packing Dimension	Height	mm	1080	1080	1088	1080	1088	*1080/1088	1088
		Width	mm	1170	1350	1846	1350	1846	*1350/1846	1846
		Depth	mm	470	620	720	620	720	*620/720	720
Unit Weight	kg		95	144	160	144	160	*144/160	160	
Pipe Connection	Type		Brazed							
	Size	Liquid	mm	12.7	12.7	15.8	12.7	15.8	*12.7/15.8	15.8
		Gas	mm	22.4	28.58	34.92	28.58	34.92	*28.58/34.92	34.92
Refrigerant Pre-Charged (At 7.5m Pipe Length)	kg		4.2	6	8.7	6.0 (x2)	8.7	*6/8.7	8.7	

Note: ■ All specifications are subject to change by the manufacturer without prior notice.

■ Cooling capacity is based on the conditions below:
Cooling - 27°C DB / 19°C WB indoor and 35°C DB outdoor.

■ Refrigerant (R-22) is pre-charged at factory shipment (Outdoor Unit).

*Given value is for 2 Nos ODU as per ODU model details mentioned above.

FLOOR STANDING TYPE (Cooling only) - Direct Air Blow Type

R-410A

Model			4.2 TR	5.0 TR	6.7 TR	8.3 TR		
	Indoor unit	Outdoor unit	FVGR05NV1	FVGR06NV1	FVGR08NV1	FVGR10NV1		
			RUR05NY1	RUR06NY1	RUR08NY1	RUR10NY1		
Power supply			380-415 V, 50 Hz, 3 Phase, 4 Wires					
Cooling capacity 1,3		kW	14.7	17.6	23.5	29.3		
		Btu/h	50000	60000	80000	100000		
		kcal/h	12600	15100	20200	25200		
Power consumption 1		kW	5.5	6.4	8.6	11.2		
Running current		A	9	10.4	14.4	18.9		
Starting current		A	72.7	80.9	118.2	135		
Power factor		%	88.2	88.8	85.9	85.5		
INDOOR UNIT			Ivory White					
Air flow rate (H)		m ³ /min	42	42	54	80		
		cfm	1480	1480	1910	2830		
Fan		Drive	Direct Drive 3 Speed					
Sound level (H/M/L) 2		dBA	59/54/50	59/54/50	60/56/51	61/57/52		
Dimensions (HxWxD)		mm	1,870x750x510	1,870x750x510	1,870x950x510	1,870x1,170x510		
Machine weight		kg	90	90	107	143		
Operation range		°CWB	14 to 25					
OUTDOOR UNIT			Ivory White					
Compressor		Type	Hermetically sealed scroll type					
		Motor output	kW	4.5	4.5	6.7	9	
Refrigerant oil		Model	Refer to the name plate of compressor					
		Charge	L	1.4	1.8	3.3	3.3	
Refrigerant charge (R-410A)		kg	2.5 (Charged for 7.5 m)	3.5 (Charged for 7.5 m)	4.5 (Charged for 7.5 m)	6.0 (Charged for 7.5 m)		
Sound level 2		380V	dBA	59	59	60	61	
		415V	dBA	60	60	61	62	
Dimensions (HxWxD)		mm	1,345x900x320		1,680x930x765			
Machine weight		kg	92	105	203	206		
Operation range		°CDB	21 to 46					
REFRIGERANT PIPING		Indoor Unit	Liquid	mm	Ø9.5 (Brazing)	Ø9.5 (Brazing)	Ø12.7 (Brazing)	Ø12.7 (Brazing)
			Gas	mm	Ø19.1 (Brazing)	Ø19.1 (Brazing)	Ø22.2 (Brazing)	Ø28.6 (Brazing)
			Drain	mm	PS 1B Internal thread			
Outdoor Unit		Liquid	mm	Ø9.5 (Flare)	Ø9.5 (Flare)	Ø12.7 (Flare)	Ø12.7 (Flare)	
			Gas	mm	Ø19.1 (Flare)	Ø19.1 (Flare)	Ø22.2 (Brazing)	Ø28.6 (Brazing)
			Drain	mm	Ø26.0 (Hole)	Ø26.0 (Hole)	-	-
Max. interunit piping length		m	50 (equivalent length 70 m)					
Max. installation level difference		m	30					

- Note: 1. Rated cooling capacities are based on the following conditions: Return air temp., 27°CDB, 19.5°CWB; outdoor temp. 35°CDB. Equiv. refrigeration piping, 5 m (horizontal).
2. Anechoic chamber conversion value, measured according to JIS parameters and criteria. During operation these values are somewhat higher owing to ambient conditions.
3. Capacity includes indoor fan motor heat.

Specifications

FLOOR STANDING TYPE (Cooling only) - Duct Connection Type

R-410A

Model	Indoor unit		8.3 TR	10 TR	13.3 TR	15.0 TR	16.7 TR	
	Outdoor unit		FVPGR10NY1	FVPGR13NY1	FVPGR15NY1	FVPGR18NY1	FVPGR20NY1	
Power supply	380-415 V, 50 Hz, 3 Phase, 4 Wires							
Cooling capacity 1,3	kW		29.3	35.2	46.9	52.8	58.6	
	Btu/h		100000	120000	160000	180000	200000	
	kcal/h		25200	30200	40300	45400	50400	
Running current	A		19.2	24.3	29	34.6	40.4	
Power consumption 1	kW		11.4	14.9	17.8	21.2	24.8	
Starting current	A		129.5	118	130.3	143.4	146.3	
Power factor	%		85.7	88.5	88.6	88.4	88.6	
INDOOR UNIT	Colour		Ivory White					
	Air flow rate (H)	m ³ /min	80	120	120	162	162	
		cfm	2830	4240	4240	5720	5720	
	Fan	Drive	Belt Drive					
		Ext. Static Pressure (mmH ₂ O)	15					
	Sound level 2	dBA	61	62	62	63	63	
	Dimensions (HxWxD)	mm	1,740x1,170x510	1,870x1,170x720	1,870x1,170x720	1,870x1,470x720	1,870x1,470x720	
Machine weight	kg	150	180	180	240	240		
Operation range	°CWB	14 to 25						
OUTDOOR UNIT	Colour		Ivory White					
	Compressor	Type	Hermetically sealed scroll type					
		Motor output	kW	9	5.0+5.0	6.7+6.7	7.5+7.5	9.0+9.0
	Refrigerant oil	Model	Refer to the name plate of compressor					
		Charge	L	3.3	5	6.5	6.5	6.5
	Refrigerant charge (R-410A)	kg	6.0 (Charged for 7.5 m)	4.5 (Charged for 7.5 m)	8.0 (Charged for 7.5 m)	8.0 (Charged for 7.5 m)	8.0 (Charged for 7.5 m)	
	Sound level 2	380V	dBA	61	61	62	63	63
415V		dBA	62	62	63	64	64	
Dimensions (HxWxD)	mm	1,680x930x765	1,680x1,240x765	1,680x1,240x765	1,680x1,240x765	1,680x1,240x765		
Machine weight	kg	206	243	319	322	329		
Operation range	°CDB	21 to 46						
REFRIGERANT PIPING	Indoor Unit	Liquid	mm	Ø12.7 (Brazing)	Ø12.7 (Brazing)	15.9 (Brazing)	15.9 (Brazing)	15.9 (Brazing)
		Gas	mm	Ø28.6 (Brazing)	Ø28.6 (Brazing)	34.9 (Brazing)	34.9 (Brazing)	34.9 (Brazing)
		Drain	mm	PS 1B Internal thread				
	Outdoor Unit	Liquid	mm	Ø12.7 (Flare)	Ø12.7 (Flare)	Ø15.9 (Flare)	Ø15.9 (Flare)	Ø15.9 (Flare)
		Gas	mm	Ø28.6 (Brazing)	Ø28.6 (Brazing)	Ø34.9 (Brazing)	Ø34.9 (Brazing)	Ø34.9 (Brazing)
		Drain	mm	-				
Max. interunit piping length	m	50 (equivalent length 70 m)						
Max. installation level difference	m	30						

- Note: 1. Rated cooling capacities are based on the following conditions: Return air temp., 27°CDB, 19.5°CWB; outdoor temp. 35°CDB. Equiv. refrigeration piping, 5 m (horizontal).
2. Anechoic chamber conversion value, measured according to JIS parameters and criteria. During operation these values are somewhat higher owing to ambient conditions.
3. Capacity includes indoor fan motor heat.

ROOFTOP SERIES (Cooling only)

R-410A

Model		5.2 TR	7.8 TR	10.4 TR	12.9 TR	15.8	18.3	20.7	26.0
		UATQ60C	UATQ90C	UATQ1 20C	UATQ150C	UATQ1 80C	UATQ240C	UATQ240C	UATQ300C
Rated Capacity	Btu	62,500	93,400	1,24,500	1,54,400	1,89,000	2,20,000	2,48,600	3,12,200
	kW	18.32	27.37	36.49	45.25	55.39	64.48	72.86	91.5
Total Power Input	kW	4.52	7.20	9.45	12.00	14.72	16.90	19.29	24.52
Total Running Current	A	8.20	13.50	17.00	24.10	27.20	33.90	38.70	46.00
COP	W/W	4.05	3.80	3.86	3.77	3.76	3.82	3.78	3.73
Power Source	V/Ph/Hz	380-415V/3/50	380-415V/3/50	380-415V/3/50	380-415V/3/50	380-415V/3/50	380-415V/3/50	380-415V/3/50	380-415V/3/50
Control Operation		Wired Control	Wired Control	Wired Control	Wired Control	Wired Control	Wired Control	Wired Control	Wired Control
Air Flow	cfm	2000	2800	4400	5000	7000	7600	8000	9000
External Static Pressure (Factory Setting)*	Pa	50-500(100)	50-500(100)	50-500(100)	50-500(150)	50-500(150)	50-500(200)	50-500(200)	50-500(250)
Fan Drive		Belt Driven	Belt Driven	Belt Driven	Belt Driven	Belt Driven	Belt Driven	Belt Driven	Belt Driven
Air Quality(Filter)	Type	Saranet	Saranet	Saranet	Saranet	Saranet	Saranet	Saranet	Saranet
	Qty	1	1	2	2	2	2	2	2
Unit Dimension (HxWxD)	mm	1150 x 1280 x 1520	1350 x 1280 x 1520	1390 x 1965 x 1830	1390 x 1965 x 1830	1690 x 1965 x 1905	1650 x 2410 x 2030	1650 x 2410 x 2030	1950 x 2410 x 2030
Packing Dimension (HxWxD)	mm	1270 x 1320 x 1710	1410 x 1320 x 1710	1440 x 2020 x 1840	1440 x 2020 x 1840	1730 x 2120 x 2020	1740 x 2570 x 2290	1740 x 2570 x 2230	2040 x 2570 x 2290
Unit Weight	Kg	350	380	590	650	840	930	940	1090
Gross Weight	Kg	370	400	620	680	870	970	980	1130
Compressor	Type	Scroll	Scroll	Scroll	Scroll	Scroll	Scroll	Scroll	Scroll
	Qty	1	1	2	2	2	2	2	2
Refrigerant (PreCharged)	Kg	9.5	11.5	5.2 + 5.2	8.5 + 8.5	8.5 + 8.5	12.0 + 12.0	10.8 + 10.8	14.0 + 14.0
Operating Range	CDB	up to 52°C	up to 52°C	up to 52°C	up to 52°C	up to 52°C	up to 52°C	up to 52°C	up to 52°C

- Note: 1. Gross Cooling Capacity Based on 27°C DB / 19°C WB Indoor and 35°C DB outdoor
2. All Units are being tested and Comply to ISO 5151 (Non-Ducted Unit) or ISO 13253 (Ducted Unit)
3. All specifications are Subjected to Change by the manufacturer without prior notice

ROOFTOP SERIES (Heat Pump)

R-410A

Model		7.8 TR	10.1 TR	12.7 TR	15.8 TR	19.0 TR	20.6 TR		
		UATYQ250Mcy19	UATYQ350Mcy1	UATYQ450Mcy1	UATYQ550Mcy1	UATYQ600Mcy1	UATYQ700Mcy1		
Nominal Cooling Capacity (Gross)	Btu/h	93300	121400	152600	190000	228000	247700		
	W	27340	35580	44720	55690	66820	72600		
Nominal Heating Capacity (Nett)	Btu/h	85000	118700	142600	184000	210500	237500		
	W	24910	34790	41790	53930	61690	69610		
Power Source	V/Ph/Hz	380 -415 /3 /50			380 -415/3 /50		380 -415/3 /50		
Refrigerant Type / Control		R410A / EXV			R410A / EXV		R410A / EXV		
EER (Gross)	W/W	3.36	3.3	3.43	3.33	3.4	3.36		
COP (Net)	W/W	3.4	3.21	3.25	3.47	3.32	3.25		
EVAPORATOR	Sound Power Level @ 100 ESP	dBA	68	72	75	82	87		
	Sound Power Level @ Std ESP	dBA	73	76	80	84	90		
	Control	Air Discharge Operation	Ducted						
CONDENSER	Air Flow	l/s/cfm	1560 / 3300	2030 / 4300	2670 / 5650	3160 / 6700	3445/7300	3917/8300	
	External Static Pressure	Pa/in.wg.	147 / 0.6	147 / 0.6	147 / 0.6	206 / 0.8	196 / 0.8	206 / 0.8	
	Condensate Drain Size	mm/in	25.4 / 1	25.4 / 1.0	25.4 / 1	25.4 / 1.0	25.4 / 1.0	25.4 / 1.0	
	Air Flow	l/s/cfm	3884 / 8230	5664 / 12000	5710 / 12100	6090 / 12900	9534 / 20200	10006 / 21200	
	Sound Power Level	dBA	82	83	83	87	90	90	
	Unit Dimension	Height	mm/in	1150 / 45.3	1028 / 40.5	1130 / 44.5	1048 / 41.3	1302 / 51.3	1454 / 57.3
		Width	mm/in	1638 / 64.5	2209 / 87.0	2209 / 87.0	2209 / 87.0	2209 / 87.0	2209 / 87.0
		Depth	mm/in	2063 / 81.2	2113 / 83.2	2113 / 83.2	2670 / 105.1	2670 / 105.1	2670 / 105.1
	Packing Dimension	Height	mm/in	1370 / 54	1200 / 47.3	1290 / 50.8	1270 / 50.0	1520 / 59.9	1670 / 65.8
		Width	mm/in	1730 / 68.2	2280 / 89.8	2280 / 89.8	2280 / 89.8	2280 / 89.8	2280 / 89.8
Depth		mm/in	2300 / 90.6	2350 / 92.6	2350 / 92.6	2900 / 114.2	2900 / 114.2	2900 / 114.2	
Unit Weight (Net)	kg/lb	445 / 981	580 / 1278	610 / 1344	780 / 1720	830 / 1830	970 / 2139		
Refrigerant Pre-charged		6.1 / 13.4	(2 X 5.8) / (2 X 12.8)	(2 X 7.2) / (2 X 15.9)	(2 X 8.7) / (2 X 19.2)	(2 X 10.4) / (2 X 22.9)	(2 X 11.6) / (2 X 25.6)		

Note: All units are being tested and comply to ISO 5151 (Non-Ducted Unit) or ISO 13253 (Ducted Unit). Cooling indoor: 27°C dB / 19°C WB, outdoor: 35°C dB / 24°C WB; Heating-indoor: 20°C dB, outdoor: 8°C dB / 6°C WB

* Also available in R-407 C

Specifications

HORIZONTAL WATER SOURCE HEAT PUMP

R-410A

Model		0.78 TR		1.49 TR		1.89 TR		2.48 TR		2.90 TR		3.55 TR		
		MWH010DRP		MWH020DRP		MWH025DRP		MWH030DRP		MWH040DRP		MWH050DRP		
Nominal Cooling Capacity	W	2750		5250		6650		8770		10200		12500		
Nominal Heating Capacity	W	3270		6100		7100		9050		10250		13000		
Air Flow Rate	m ³ /h	580		1050		1250		1700		1900		2300		
Power Supply		220V~/50Hz												
ESP	Pa	20		30		30		30		50		50		
Dimension (Length×Width×Height)	mm	895×520×375		1265×655×435		1265×705×435		1390×745×435		1450×795×460		1450×795×510		
Condenser	Type	Tube in Tube Heat Exchanger												
	Water Flow Rate	m ³ /h	0.61		1.12		1.42		1.94		2.14		2.67	
	Water Pressure Drop	kPa	13		34		60		40		40		60	
	Water Pipe Connection		R3/4		R3/4		R3/4		R3/4		R3/4		R3/4	
Compressor		Rotary												
Rated Power	Cooling	W	700		1220		1520		2230		2250		2850	
	Heating	W	740		1280		1540		2050		2300		2780	
Rated Current	Cooling	A	3.38		5.93		7.46		11.03		10.57		13.76	
	Heating	A	3.45		5.95		7.54		10.17		10.77		13.43	
Condensate Drain Pipe	mm	φ20												
Refrigerant	Type	R410A												
	Charge	kg	0.74		1.35		1.46		0.95×2		1.3×2		1.55×2	
Sound Pressure Level	dB(A)	34		40		45		48		44		47		
Weight	kg	56		101		103		125		155		161		

R-410A

Model		4.55 TR		5.40 TR		6.98 TR		8.39 TR		9.48 TR		10.66 TR		
		MWH060DRP		MWH070DRP		MWH080DRP		MWH100DRP		MWH125DRP		MWH150DRP		
Nominal Cooling Capacity	W	16000		19000		25000		29500		33500		37500		
Nominal Heating Capacity	W	16200		21500		25000		31500		35500		45000		
Air Flow Rate	m ³ /h	2800		3400		5000		6000		7000		8000		
Power Supply		380V/3N/50Hz												
ESP	Pa	80		80		80(50/100/150)		100(80/150/200)		100(80/150/200)		150(100/200/250)		
Dimension (Length×Width×Height)	mm	1580×850×520		1670×855×520		1756×1000×660		1970×1150×708		1970×1150×708		2226×1200×736		
Condenser	Type	Tube in Tube Heat Exchanger												
	Water Flow Rate	m ³ /h	3.3		4.22		5.23		6.12		7.11		7.78	
	Water Pressure Drop	kPa	60		61		73		45		55		65	
	Water Pipe Connection		R3/4		R1		R1-1/4		R1-1/4		R1-1/4		Rc1-1/4	
Compressor		Scroll												
Rated Power	Cooling	W	3300		4900		5600		6300		8500		9450	
	Heating	W	3200		4800		5400		6400		8100		10300	
Rated Current	Cooling	A	5.91		8.63		11.45		13.68		15.89		17.78	
	Heating	A	5.83		8.41		11.11		13.87		14.46		18.89	
Condensate Drain Pipe	mm	φ20						φ34						
Refrigerant	Type	R410A												
	Charge	kg	3.5		2.8		3.5		3.2×2		3.0×2		3.7×2	
Sound Pressure Level	dB(A)	49		54		55		59		59		60		
Weight	kg	198		208		245		365		375		450		

- Notes:
- Specifications will be subjected to change by manufacturer without prior notice.
 - Cooling capacity is based on 27°C (DB), 19°C (WB) air inlet temperature and 30°C water inlet temperature, 35°C water outlet temperature.
 - Heating capacity is based on 20°C (DB), 15°C (WB) air inlet temperature and 20°C water inlet temperature.





Contact Address

DAIKIN AIRCONDITIONING INDIA PVT. LTD.

12th Floor, Building No. 9
Tower A, DLF Cyber City
DLF Phase III, Gurgaon 122002
Haryana, India
Tel: 0124-4555444, Fax: 0124-4555333

Sales & Service Offices

Ahmedabad

Tel: 079-26583013/14

Bengaluru

Tel: 080-25590452/54

Bhubaneswar

Tel: 0674-2546476

Chandigarh

Tel: 0172-5089862/64

Chennai

Tel: 044-40807676

Cochin

Tel: 0484-2808646

Delhi NCR

Tel: 011-43834400/4500

Ghaziabad

Tel: 0120-4205851

Indore

Tel: 0731-4005864

Jaipur

Tel: 0141-2218903

Kolkata

Tel: 033-23574259/61

Lucknow

Tel: 0522-2787307/340

Ludhiana

Tel: 0161-5077028/29/30

Mumbai

Tel: 022-30926666

Patna

Tel: 0612-2522477

Pune

Tel: 020-25560300

Raipur

Tel: 0747-1115412

Ranchi

Tel: 0763-5093703

Secunderabad

Tel: 040-49134283

Vijaywada

0866-2952224/25/26



Customer Contact Centre:

SMS: <DAIKIN> to 92 101 88 999

Give missed call: to 92 101 88 999

Customer Support no.: 011-40319300 / 1860 180 3900

Email: customerservice@daikinindia.com

Visit us at: www.daikinindia.com

Buy at: www.mydaikinstore.com

f /daikinindia

t /daikinindia

www.daikinindia.com/blog

in /company/daikin-airconditioning-india-pvt.-ltd.

Disclaimer

As a continuing policy of product innovation at Daikin, the design and specifications are subject to change without prior notice. The visuals of the products in the brochure are representative only, actual products might differ from the ones shown.

'Products mentioned in this brochure comply with RoHS regulations as per E-waste (Management & Handling) Rules, 2011 and should not be mixed with general household waste at the end of their useful life.' For more details kindly visit our website www.daikinindia.com or contact our customer care centre at 011-40319300 / 1860 180 3900.

